



ÜRETİMLERİMİZ

MODEL BS

Analog Phase Angle Controller - Time Base

- AC Control 3Q Triac & Back to Back S.C.R.
- Product withstand Temperature 150°C.
- "19.5 & 22.5 MM SLIM Height" SSM Design.
- "31 MM Height" Inbuilt "C-56" Heat sink SSM Design.
- With easy open & lock IP 20 protection Flaps on I/P & O/P Terminals.
- Time Base Phase Angle control SSM.
- Rating from 16 Amp to 200 Amp @25°C 440 VAC.
- Short Circuit Protected SSM up to 115 Amp per phase current by help of suitable "B" curve MCB.
- No need to use semiconductor Fuse due to short circuit protected SSM.
- Fire Retardant Plastic as per UL94 VO GRADE.
- New improved SEMS Screw - Washers input & Output terminals.
- Improved Direct Bonded Copper (DBC) for higher Amp MODULEs.
- High resistance to aggressive chemicals and dust due to special Potting.
- Logic compatibility, Fast switching, Low coupling capacitance.
- Inbuilt transient voltage suppressor.



5mm AL PLATE
Only Al plate take 14 Amp Load Current at 40°C.



C56 HEAT SINK
Only C56 Heat Sink take 20 Amp Load Current at 40°C.



2mm CU PLATE

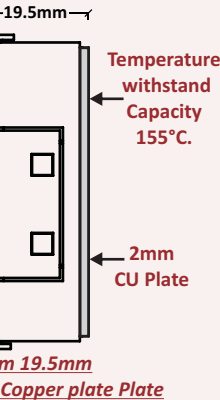
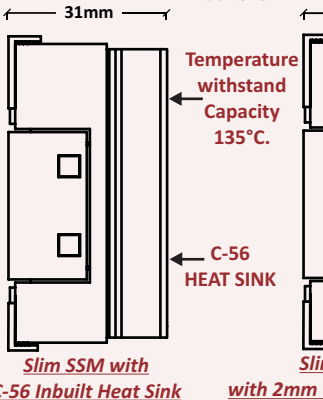
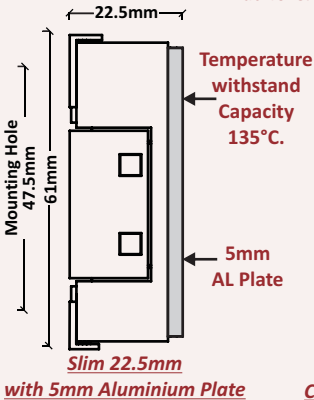
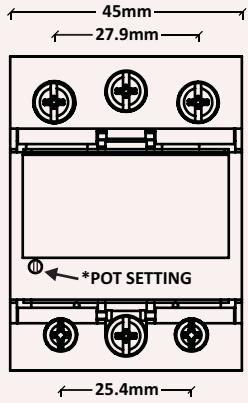

ORDERING FORMAT

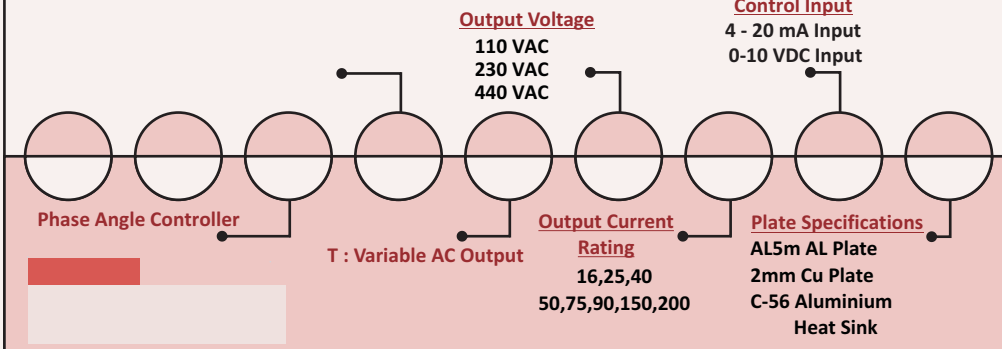

*POT SETTING:
By Providing 50% Input value we can set the 50% Line Voltage by Pot setting.

NOTE 1 : AL5 Plate available for 16Amp to 50Amp
CU2 Plate available for 75Amp to 200Amp
C56 Heat sink available for 16Amp to 50Amp

BS DBC MODULE

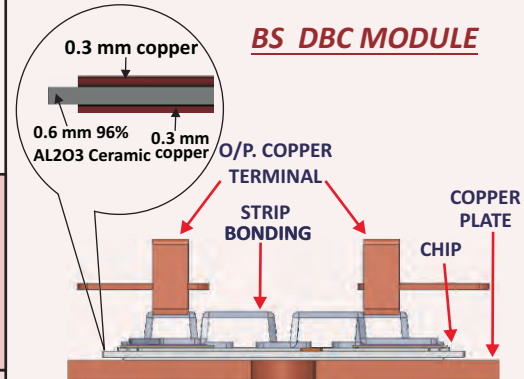

Direct Copper Bonded (DCB) or Direct Bonded Copper (DBC) improves the conduction of heat from semiconductor chip to external heat sink as well as reduces mechanical stress in connection to major load changes. Here two layers of 0.3 mm copper is bonded to ceramic at temperature above 1020 °C. Coefficient of thermal expansion of copper is higher than ceramic (96% AL2O3) so a joint layer is generated between them at high temperature which will not cause thermal stress or fatigue on power output semiconductors.

ADVANTAGES

- ❖ Output will vary accordingly to input 4-20 mA or 0-10 VDC in sinusoidal waveform in S - Curve pattern
- ❖ Isolated Analog Input compatibility low Input impedance <100E for Input 4-20 mA
- ❖ 4 Terminal device no need of external Power Supply.
- ❖ System temperature accuracy less of 5% can be achieved
- ❖ 5 Nos. SSMs can be put in series by one 4-20mA O/P. with 500E O/P impedance Temperature Controller.

DISADVANTAGES

- ❖ Generation of Electrical Noise (RFI)
- ❖ Generation of Spike Voltage
- ❖ Generate Harmonic frequency due to choppy Sine wave pattern
- ❖ Generation of extra Volt Amp reactive (VARs)
- ❖ Power factor is Poor
- ❖ Generation of high Neutral current due to Phase angle control and voltage difference in 3 phase line Supply

Note : Specifications are subject to change without prior notice.

Web: www.biltekelektrik.com Email : info@biltekelektrik.com

Tel: +90-212-545-73-50, Fax: +90-212-545-73-50



ÜRETİMLERİMİZ

General Specification

Max Barrier Layer Temperature (T_{max})	< 125 °C
Ambient Temperature Range (T_{amb})	0-85 °C
SSM Storage Temperature Range (T_{st})	-40°C to 80°C
Input Terminal Screw Torque Range	T = 1.6 N.m (Max.)
Output Terminal Screw Torque Range	T = 2.5 N.m (Max.)
Power Factor COS ϕ @ Max. Load @ 480 VAC	> 0.55
Housing Material	UL-94 V0 Grade
Base Plate	5mm Aluminium, 2mm Copper, C-56 Heat Sink
SSM Weight	≤ 120 grams
Control Input Electrical Wire Size (Max.)	Up to 2.1 sq mm(14 AWG)
Power Output Electrical Wire Size (Max.)	Up to 33.6 sq mm(2 AWG)
Test Standards:	ROHS,IP20
Pending Approvals:	UL 508,VDE ,TUV ,CSA 22-2 IEC 60947-5-1:2016 IEC 62314:2006

Input Technical Specifications

Parameters	Unit	ANALOG INPUT	
Control Voltage Range	V	4-20 mA*	0-10 VDC
Control Supply Current Consumption	mA		
Input Impedance (Current Regulator Circuit Impedance)	Ω	≤100 Ω	560 Ω
Phase Angle Control	-	50 Hz-10 mS Half Cycle 60 Hz-8.33 mS Half Cycle	

* For Analog Phase angle Control SSM 4-20 mA Input SSM & 0-10 VDC Input SSM both are different. Please Specify the Input by last 3 digits as per ordering format.

NOTE : Please do not give DC Voltage Input at 4-20 mA Input SSM, If DC voltage is given SSM control Input will be bad.

Analog Phase Angle Control Time Base Waveform - Single Phase

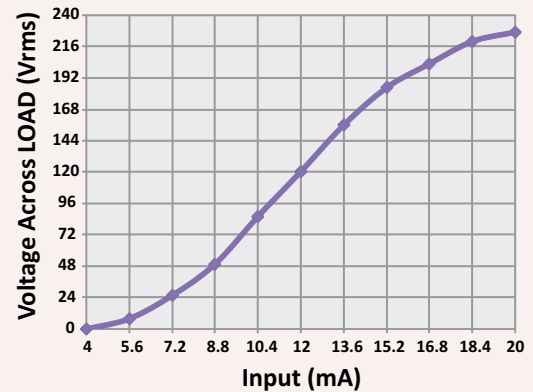

Digital Oscilloscope



SCR Parameter Tester



V_{TM} Tester



H.V. Insulation Break Down Tester



dv/dt Tester



I_{TSM} Tester



Output Technical Specifications @ 25°C Unless Specified

Parameters	Symbol	Unit	16 Amp	25 Amp	40 Amp	50 Amp	75 Amp	90 Amp	150 Amp	200 Amp
Operating Voltage Range	V_{AC}	V_{RMS}	110 VAC/ 230 VAC/440 VAC *POT SETTING							
Operating Frequency Range	f	Hz	47-63 Hz							
Peak Inverse Voltage	PIV	V_{PK}	800	800	800	1200	1200	1200	1200	1200
Max. Surge Voltage With Stand Capacity (<1 Second)	V_{surge}	V_{RMS}	2700 V_{RMS} (3800 V_{PK})							
Rated Operational Current AC51a @ 20°C (Resistive Load)	I_T	Amp	16	25	40	50	75	90	150	200
Maximum Load Short Circuit Protection Current @ 55°C	I_{SC}	Amp	-	-	-	15	50	63	80	115
"B" Curve D.P. MCB Rating for Short Circuit Protection	-	Amp	-	-	-	16	50	63	80	125
NON Repetitive Surge Peak ON-State Current @ Rated V_{RRM} applied for 1/2 Cycle $t=10$ mS / $t=8.33$ mS (50 Hz/60 Hz)	I_{TSM} @ 50 Hz	A_p	120	260	420	800	1100	1200	1750	2250
	I_{TSM} @ 60 Hz	A_p	126	273	441	840	1155	1260	1837	2360
Max. I^2t for Fusing @ $t=10$ mS (50Hz)	I^2t	A^2s	72	340	880	3000	6000	7200	15000	25000
Max. I^2t for Fusing @ $t=8.33$ mS (60Hz)	I^2t	A^2s	65	305	795	2750	5470	6510	13850	22880
Max. Peak ON-state voltage Drop at Full Control	V_{TM}	V_{RMS}	≤5	≤5	≤5	≤5	≤5	≤5	≤5	≤5
Minimum Isolation Resistance between Input Terminals (+3,-4) to Output Terminals (~1,~2) @ 500 VDC	Ω	G Ω	50	50	50	50	50	50	50	50
Isolation Voltage Input Terminals (+3,-4) to Output Terminals (~1,~2) for 1 Minute (PHT Type)	V_{ISO}	kV	6	6	6	6	6	6	6	6
Isolation Voltage Input & Output Terminal (+3,-4,~1,~2) to Body Isolation for 1 Minute	V_{ISO}	kV	4	4	4	4	4	4	4	4
Max. Rate of Rise OFF-State Voltage	dv/dt	V/ μ S	400	400	500	600	600	1000	1000	1000
Max. Rate of Rise OFF-State Current	di/dt	A/ μ S	50	22	50	100	125	150	300	300
Max. Peak Repetitive Forward OFF-State Voltage	V_{DRM}	V	800	800	800	1200	1200	1600	1600	1600
Max. Peak Repetitive Forward OFF-State current	I_{DRM}	mA	0.05	0.05	0.05	0.1	0.1	0.05	0.3	0.3
Max. Peak repetitive reverse off-state Voltage	V_{RRM}	V	800	800	800	1200	1200	1600	1600	1600
Max. Peak repetitive reverse off-state current	I_{RRM}	mA	0.05	0.05	0.05	0.1	0.1	0.05	0.3	0.3
Max. DC Gate Trigger Voltage	V_{GT}	V	1.2	1.2	1.5	1.5	1.3	1.5	1.3	1.3
Max. DC Gate Trigger Current	I_{GT}	mA	50	50	50	8.8	10	20	150	150
Turn OFF Time	t_q	μ S	25	20	35	120	150	200	100	100
Maximum Latching Current	I_L	mA	80	100	100	160	180	200	400	500
Maximum Holding Current	I_H	mA	60	75	60	150	150	150	200	250
Thermal Resistance R θ (Junction to case)	R $\theta(j-c)$	°C/W	0.8	0.6	0.52	0.35	0.22	0.2	0.09	0.07
OFF State SSM Leakage Current @ Rated Voltage & Frequency (Snubber Leakage)	I_{leak}	mA	For 230 VAC < 1 mA			For 230 VAC < 1.5 mA				
			For 440 VAC < 2 mA			For 440 VAC < 3 mA				
SCCR Current Rating (less than 100 μ S)	I_{SCCR}	kA	-	-	-	10 kA	10 kA	10 kA	10 kA	10 kA
Weight	W	gm	≤ 110	≤ 110	≤ 110	≤ 110	≤ 120	≤ 120	≤ 120	≤ 120



ÜRETİMLERİMİZ

Analog Phase Angle Controller - Time Base

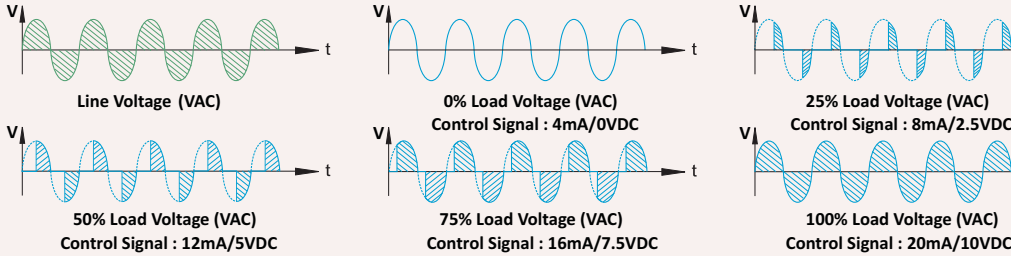

Analog Phase angle control SSMs are used when proportional output is required with respect to control input. Two different input range available for control signal 4-20mA or 0-10VDC. Our 4-20mA input SSM's input impedance is less than 100E, so by single temperature controller our 5Nos. 4-20mA SSMs can be driven. These SSMs are highly advantageous in closed application or when soft start of load is required to avoid inrush currents. It is also suitable where precise temperature should be maintained. Above waveforms shows functionality of Analog phase angle control SSM

Analog Phase Angle Controller Waveform

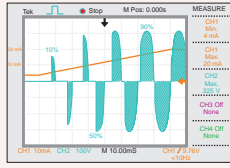

CONNECTION DIAGRAM

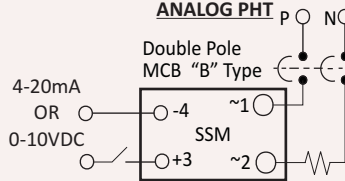

THERMAL DERATING CURVE WITH HEAT SINK

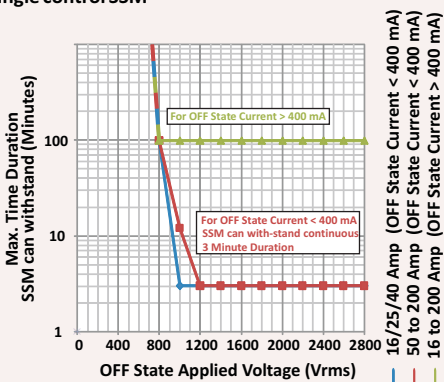
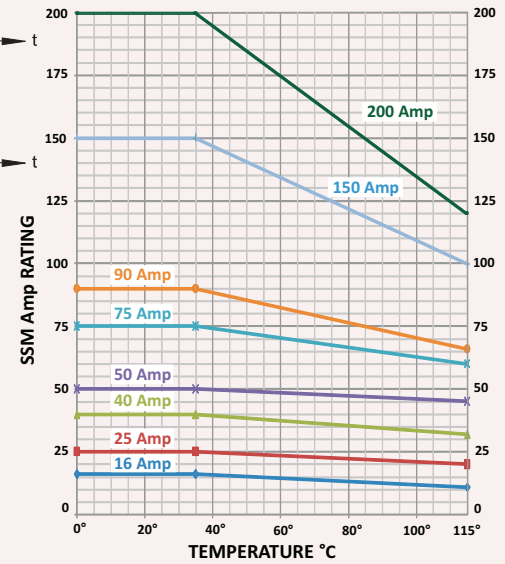

BLOCK DIAGRAM

ANALOG PHASE ANGLE CONTROLLER

- TIME BASE

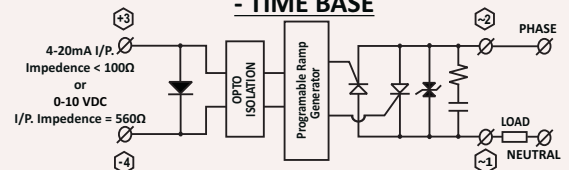

*Input 4-20mA & 0-10 VDC both are different. Please see ordering format for differentiation.

ANALOG PHASE ANGLE CONTROLLER TIME BASE TYPE SSM Connection Diagram

Connection Diagram Of BS Model Input 4-20mA Three Phase Star With Neutral

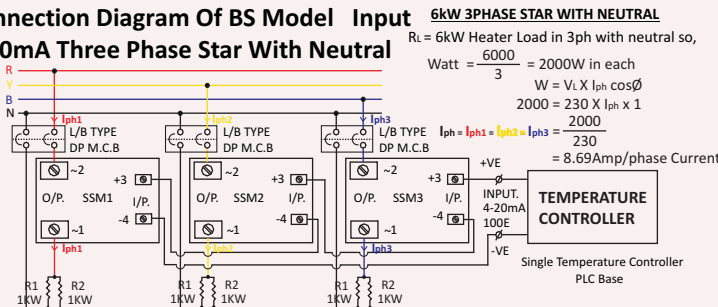

* Phase Angle Controller SSM will not work star without neutral

Connection Diagram Of BS Model Input 4-20mA 440VAC Load In Open Delta

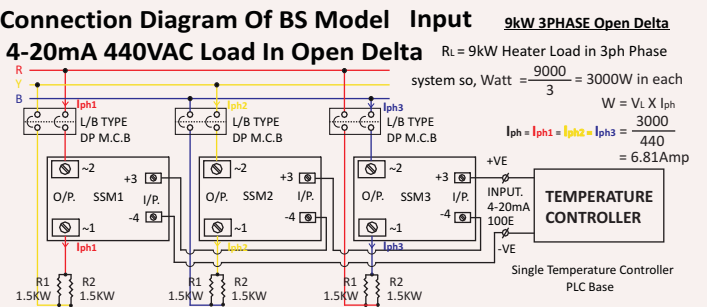

* Phase Angle Control SSM will not work in close delta configuration

Connection Diagram Of BS Model Input 0-10VDC Three Phase Star With Neutral

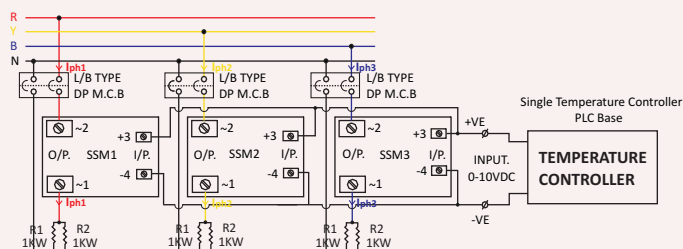

* Phase Angle Controller SSM will not work star without neutral

Connection Diagram Of BS Model Input 0-10VDC 440VAC Load In Open Delta

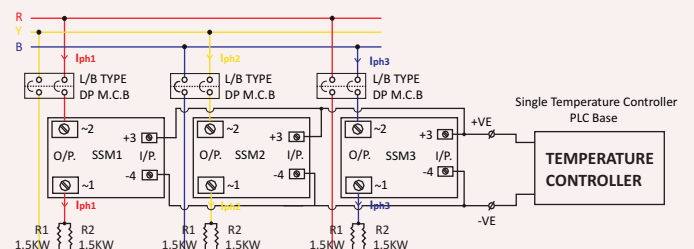

* Phase Angle Control SSM will not work in close delta configuration



ÜRETİMLERİMİZ

AIRFLOW FOR EFFICIENT HEAT TRANSFER

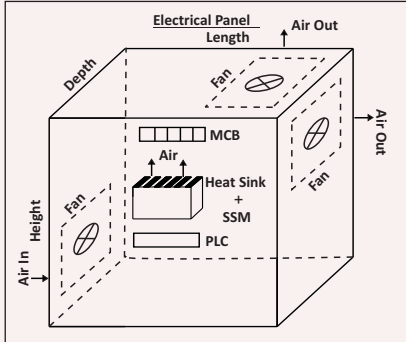

- Heat Sink Fins should be in Vertical Position So that Hot Air flow from Bottom to Top - Self Cooling.
- Our heat sinks are designed in such manner that horizontal & vertical convection both occurs properly.
- Keep 20mm Gap at Top and Bottom of Heat Sink.
- Apply Heat Sink Compound between SSM and Heat Sink.
- The Screw should be tightened properly so that total Exposed Aluminum is Sufficient to Dissipated One Watt of Heat Generated.
- **Advantages of using DBC Technology :**
Copper has higher thermal conductivity So more heat dissipation of junction to case & case to sink. Due to this thermal resistance $R_{\theta jc}$ is very less. Reduction in thermal resistance increases thermal efficiency of lower system.

THERMAL CALCULATION	
$\Delta T = T_j - T_A$	= $P(R_{\theta jc} + R_{\theta cs} + R_{\theta sa})$
T_j	= Junction Temperature (°C) 125 °C
T_A	= Ambient Temperature(°C)
P_d	= Power Dissipation (Watts) Voltage Drop X Load Current
$R_{\theta jc}$	= Thermal Resistance Junction to Case °C/W
$R_{\theta cs}$	= Thermal Resistance of Heat Sink Compound (0.2°C/W Type)
$R_{\theta sa}$	= Thermal Resistance of External Heat Sink (°C/W) it depend upon Length, Width, Expose Aluminum (0.5 to 5)

NOTE : If SSM Current Capacity is high and it is mounted on lower capacity heat sink than maximum load current will also decrease as heat dissipation area decreases.
Example: 1) 50Amp SSM used for 26Amp Load Current than "G-68" Type of Heat Sink. **2)** 50Amp SSM used for 32Amp Load Current than "B-48" Type of Heat Sink.

HEAT SINK SELECTION GUIDE (Resistive LOAD)

BS MODEL / HEATSINK	HEATSINK RATING	16 AMP SSM	25 AMP SSM	40 AMP SSM	50 AMP SSM	75 AMP SSM	90 AMP SSM	150 AMP SSM	200 AMP SSM
BAL5	12	8.5	10	12	12	-	-	-	-
BC-56	16	10	12	14	16	-	-	-	-
BG-68	26	-	16	18	26	-	-	-	-
BB-48	36	-	-	-	32	36	36	-	-
BB-72	60	-	-	-	-	55	60	-	-
BA-100	80	-	-	-	-	-	65	75	80
BA-190	Upto 115 A for 1 SSM	-	-	-	-	-	-	115*	115*
	Upto 132 A for 3 SSM	-	-	-	-	-	36 A x 3 = 108 A	40 A x 3 = 120 A	44 A x 3 = 132 A
BA-190 WITH FAN	Upto 115 A for 1 SSM	-	-	-	-	-	-	115*	115*
	Upto 156 A for 3 SSM	-	-	-	-	-	40 A x 3 = 120 A	45 A x 3 = 135 A	52 A x 3 = 156 A
BA-285	Upto 210 A for 3 SSM	-	-	-	-	-	-	65 A x 3 = 195 A	70 A x 3 = 210 A
BA-285 WITH FAN	Upto 240 A for 3 SSM	-	-	-	-	-	-	75 A x 3 = 225 A	80 A x 3 = 240 A

* As per UL 508 2 AWG (33.6 Sq. mm) wire can draw 115 Amp at 40°C.

TYPE OF HEATSINKS / CURRENT RATING / R θ SA / SURFACE AREA / MECHANICAL DIMENSIONS / WEIGHT

HEAT SINK TYPE "BC-56" + DIN RAIL
35mm Plastic Din Rail to SSM 10kV Isolation
M4 Screw

TYPE "C-56"
Model BS-1 Nos.
Current upto
16Amp @40 C
with Din Rail 42mm,
Thermal Resistance
 $R_{\theta SA} = 4^{\circ}C/W$
 $R_{\theta SA} = 277.15 K/W$
 $\dot{A}T = 75 C$
Surface Area:
353mm²x56mm
=19768mm²
43mm(W)x 56mm(L)
x 13.5mm(H) + SSM
Inbuilt Heat Sink IN 901 SSM MODEL Weight : @ 57gms
No Separate Heat Sink available

HEAT SINK TYPE "BG-68" + DIN RAIL
35mm Plastic Din Rail to SSM 10kV Isolation
M3 Screw

TYPE "G-68"
Model BS-1 Nos.
Model BS-1 Nos.
Current upto
26Amp @40°C
with Din Rail 22.5mm,
Thermal Resistance
 $R_{\theta SA} = 2.5^{\circ}C/W$
 $R_{\theta SA} = 275.65 K/W$
 $\dot{A}T = 75^{\circ}C$
Surface Area:
491mm²x68mm
=33388 mm²
44mm(W) X 68mm(L)
X 32mm(H) + SSM
Weight : @ 95gms

HEAT SINK TYPE "BB-48" + DIN RAIL
35mm Plastic Din Rail to SSM 10kV Isolation
M4 Screw

TYPE "B-48"
Model BS-Upto 2 Nos.
Model BS-1 Nos.
Current upto
36Amp @40 C
with Din Rail 42mm
Thermal Resistance
 $R_{\theta SA} = 1.17^{\circ}C/W$
 $R_{\theta SA} = 274.32 K/W$
 $\dot{A}T = 75 C$
Surface Area:
2630mm²x48mm
=126240 mm²
48mm(W) X 87mm(L)
X 80mm(H) + SSM
Weight : @ 310gms

HEAT SINK TYPE "BB-72" + DIN RAIL
35mm Plastic Din Rail to SSM 10kV Isolation
M4 Screw

TYPE "B-72"
Model BH-Upto 3 Nos.
Model BS-1 Nos.
Current upto
60Amp @40 C
with Din Rail 42mm
Thermal Resistance
 $R_{\theta SA} = 0.85^{\circ}C/W$
 $R_{\theta SA} = 274 K/W$
 $\dot{A}T = 75 C$
Surface Area:
2630mm²x72mm
=189360 mm²
72mm(W) X 87mm(L)
X 80mm(H) + SSM
Weight : @ 500gms

HEAT SINK TYPE "BA-100" + DIN RAIL
35mm Plastic Din Rail to SSM 10kV Isolation
M4 Screw
Joint Plate

TYPE "A-100"
Model BS-Upto 2 Nos.
Model BS3-Upto 1 Nos.
Current upto
80Amp @40 C
with Din Rail 42mm
Thermal Resistance
 $R_{\theta SA} = 0.65^{\circ}C/W$
 $R_{\theta SA} = 273.83 K/W$
 $\dot{A}T = 75 C$
Surface Area:
2630mm²x100mm
=263000 mm²
100mm(W) X 87mm(L)
X 80mm(H) + SSM
Weight : @ 690gms



ÜRETİMLERİMİZ

TYPE OF HEATSINKS / CURRENT RATING / R_{θSA} / SURFACE AREA / MECHANICAL DIMENSIONS / WEIGHT

HEAT SINK TYPE "BA-190" WITH OUT FAN

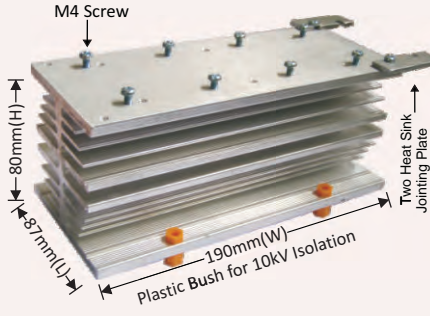

TYPE "A-190" WITH OUT FAN
Model BS-Upto 4 Nos.
Model BS-Upto 1 Nos.
Model BSH-Upto 4 Nos.
Current upto 132Amp @40°C
with Din Rail 42mm
Thermal Resistance
R_{θSA} = 0.33°C/W
R_{θSA} = 273.48 K/W
ΔT= 75°C
Surface Area:
2630mm²X190mm
=499700 mm³
190mm(W) X 87mm(L)
X 80mm(H) + SSM
Weight : @ 1300gms

HEAT SINK TYPE "BA-190" WITH 230VAC FAN

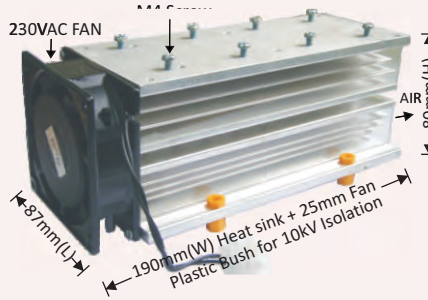

TYPE "BA-190" WITH 230VAC FAN
Model BS-Upto 4 Nos.
Model BS3-Upto 1 Nos.
Model BH-Upto 4 Nos.
Current upto 156Amp @40°C
with Din Rail 42mm
Thermal Resistance
R_{θSA} = 0.22°C/W
R_{θSA} = 273.37 K/W
ΔT= 75°C
Surface Area:
2630mm²X190mm
=499700 mm³
190mm(W) X 87mm(L)
X 80mm(H) + SSM
Weight : @ 1530gms

HEAT SINK TYPE "BA-285" WITH OUT FAN

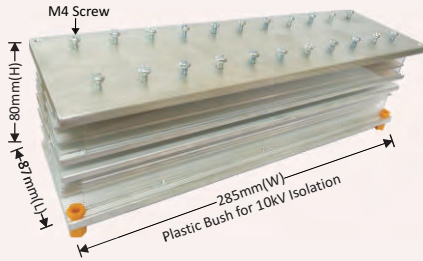

TYPE "A-285" WITH OUT FAN
Model BS-Upto 6 Nos.
Model BS3-Upto 2 Nos.
Model BH-Upto 11 Nos.
Current upto 210Amp @40°C
with Din Rail 42mm
Thermal Resistance
R_{θSA} = 0.09°C/W
R_{θSA} = 273.24 K/W
ΔT= 75°C
Surface Area:
2630mm²X285mm
=749550 mm³
285mm(W) X 87mm(L)
X 80mm(H) + SSM
Weight : @ 1950gms

HEAT SINK TYPE "BA-285" WITH 230VAC FAN

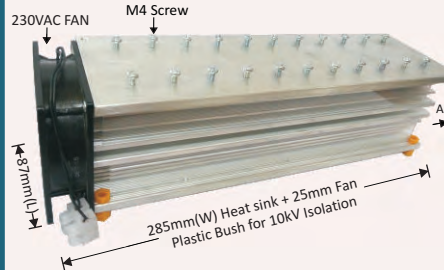

TYPE "A-285" WITH 230VAC FAN
Model BS-Upto 6 Nos.
Model BS3-Upto 2 Nos.
Model BH-Upto 11 Nos.
Current upto 240Amp @40°C
with Din Rail 42mm
Thermal Resistance
R_{θSA} = 0.04°C/W
R_{θSA} = 273.19 K/W
ΔT= 75°C
Surface Area:
2630mm²X285mm
=749550 mm³
285mm(W) X 87mm(L)
X 80mm(H) + SSM
Weight : @ 2175gms

Note : Specifications are subject to change without prior notice.

Web: www.biltekelektrik.com **Email :** info@biltekelektrik.com

Tel: +90-212-545-73-50, **Fax:** +90-212-545-73-50